

1 INFORMATION ON THIS DOCUMENT

1.1 Function

The present instruction manual provides information on installation, connection and safe use for the following articles: **FC •78, FD •78, FL •78, FP •78, FC •79, FD •79, FL •79, FP •79, FC •80, FD •80, FL •80, FC •83, FD •83, FL •83, FC •84, FD •84, FL •84.**

1.2 Target audience

The operations described in this instruction manual must be carried out by qualified personnel only, who are fully capable of understanding them, and with the technical qualifications required for operating the machines and plants in which the safety devices are to be installed.

1.3 Application field

These instructions apply exclusively to the products listed in paragraph Function, and their accessories.

1.4 Original instructions

The Italian language version is the original set of instructions for the device. Versions provided in other languages are translations of the original instructions.

2 SYMBOLS USED

 This symbol indicates any relevant additional information.

 Attention: Any failure to observe this warning note can cause damage or malfunction, including possible loss of the safety function.

3 DESCRIPTION

3.1 Device description

The rope safety switches discussed in these usage instructions are safety devices designed and implemented for installation to automatic machines (typically conveyor belts or very long machines), where a simple stop function is required (in the versions without reset device, articles **F••79, F••80**), or an emergency stop function is required (in the versions with reset device, articles **F••78, F••83, F••84**) from any position and on any manual intervention on the rope.

The devices are equipped with an integrated self-monitoring function, which is able to signal – by opening electrical contacts – any rope loosening or breakage.

 Attention: To implement emergency stop functions, as specified in standard EN ISO 13850, use only series **F••78, F••83** and **F••84** devices, as they are equipped with a latching mechanism that retains the electric contacts in the open position, until the operator intervenes on the reset device manually.

3.2 Intended use of the device

- The device described in this manual is designed to be applied on industrial machines for implementation of the simple stop function (articles **F••79, F••80**), or of the emergency stop function (articles **F••78, F••83, F••84**).

- The direct sale of this device to the public is prohibited. Installation and use must be carried out by qualified personnel only.

- The use of the device for purposes other than those specified in this manual is prohibited.

- Any use other than as expressly specified in this manual shall be considered unintended by the manufacturer.

- Also considered unintended use:

a) using the device after having made structural, technical, or electrical modifications to it;

b) using the product in a field of application other than as described in paragraph TECHNICAL DATA.

4 INSTALLATION INSTRUCTIONS

 Attention: Installing a protective device is not sufficient to ensure operator safety or compliance with machine safety standards or directives. Before installing a protective device, perform a specific risk analysis in accordance with the key health and safety requirements in the Machinery Directive. The manufacturer guarantees only the safe functioning of the product to which this instruction manual refers, and not the functional safety of the entire machine or entire plant.

4.1 Head orientation

If necessary, it is possible to adjust the position of the head, in 90° rotations, at the machine, in order to turn the device to the position best suited to the application.

Remove the 4 screws from the top part of the head, and rotate the head to the desired position, without physically separating the head from the body of the device. Tighten the 4 screws to a torque from 0.8 to 1.2 Nm.

 Attention: During this operation, take extra care not to introduce foreign particles into the device; such as dust, liquids, or pollutants of any type. Should the head separate fully from the body when rotated, do not proceed with the device installation, as certain internal parts could be unseated, and correct device function cannot be ensured.

4.2 Fixing of the device

 Attention: Always affix the device with at least 2 M5 screws. Always use screws with a resistance class of 4,6 or higher, and flat seating heads. Install the screws with medium resistance thread lock, and a number of threads engaged equal to or greater

than the screw diameter. The device must never be fixed with less than 2 screws. The tightening torque of the screws must be between 2 and 3 Nm.

4.3 Rope installation

 Attention: we recommend exclusive use of original accessories (ropes, pulleys, terminals, jumpers, and stay bolts) to ensure the stated device performance.

Follow the below procedure to connect the actuation rope.

1) Install, to the first end of the rope, a VF AF-MR5 terminal; or alternatively, a VF M870 terminal in conjunction with a VF C870 jumper.



Terminal
Article VF AF-MR5



Terminal
Article VF M870



Jumper
Article VF C870

2) At the other end of the rope, install one of the following stay bolts: VF AF-TR5, VF AF-TR8, VF AF-TR2X, VF T870. If you are using a VF AF-TR2X or VF T870 stay bolt, attach the rope to the stay bolt with a VF AF-MR5 terminal or, alternatively, with a VF M870 terminal in conjunction with a VF C870 jumper.

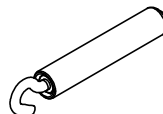

Stay bolt
Article VF AF-TR5

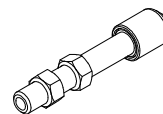

Stay bolt
Article VF AF-TR8

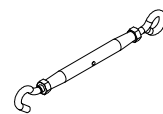

Stay bolt
Article VF AF-TR2X

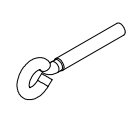

Stay bolt
Article VF T870

3) If the rope is longer than 6 m (for articles with longitudinal head, **F••78, F••79**) or 16 m (for articles with transversal head **F••80, F••83, F••84**), you must use VF AF-CA5 or VF AF-CA10 pulleys, to support the weight of the rope. The distance between the pulleys, or between the pulley and the switch, must never exceed 3 m (for articles with longitudinal head) or 5 m (for articles with transversal head).

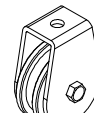

Pulley
Article VF AF-CA5

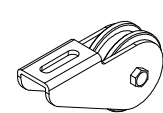

Pulley
Article VF AF-CA10

4) Tension the rope connected to the switch, by screwing or unscrewing the threaded stem of the stay bolt, until the end of the black indicator (1) on the head of the device reaches half of the green ring (2) - see Figure.

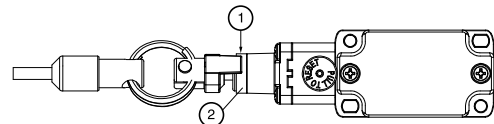

5) Lock the stay bolt in position by tightening the corresponding lock nut (where present).

6) For articles with reset device, pull the blue knob so that the electrical safety contacts close. Below the knob, a steady green ring should appear, to indicate correct reset device state.

 When first installed, the rope tends to lengthen as a result of its natural detensioning; we therefore advise you to check the rope for correct tension, 24 hours after completing installation.

4.4 Installation examples

 Attention: Never exceed the maximum rope lengths shown in the following examples, under any circumstances.

4.4.1 Installation examples for switches with longitudinal head

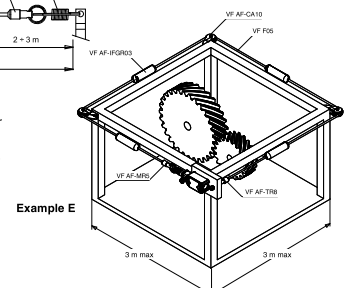
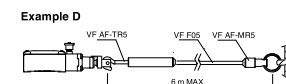
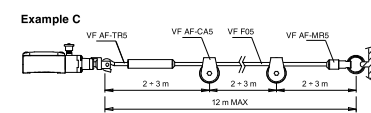
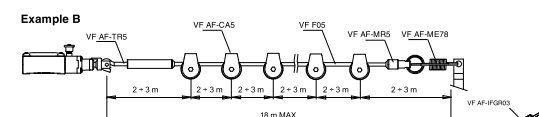
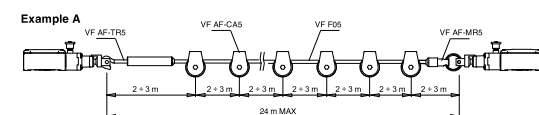

4.4.2 Installation examples for switches with transversal head

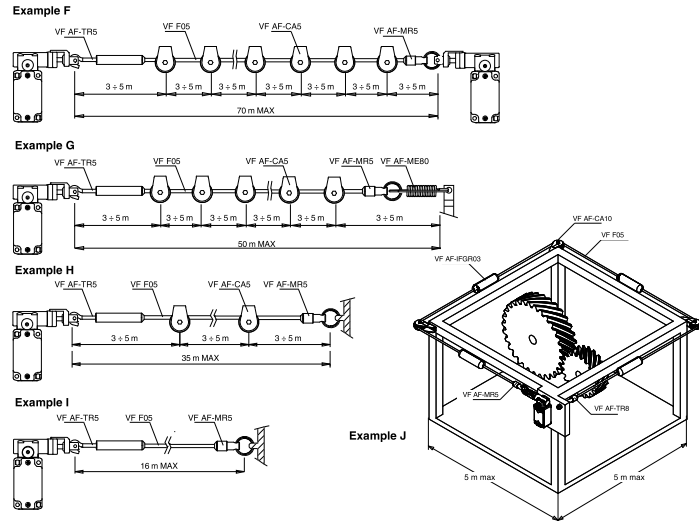

4.5 Rope tightening

The maximum rope lengths listed in paragraph INSTALLATION EXAMPLES are reduced, if the ambient temperature is subject to considerable variations.

The max. recommended lengths are indicated in the following diagrams in accordance with the temperature fluctuations (temperature differences) to which the switch may be exposed at the point of use.

The values indicated in the graph are guaranteed only for use of the original rope and accessories.

4.5.1 Maximum lengths for switches with longitudinal head

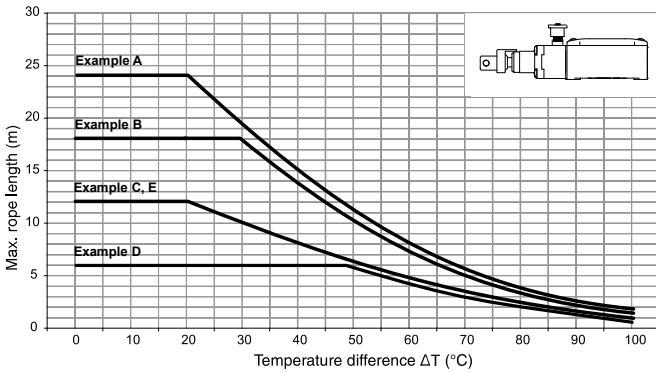

4.5.2 Maximum lengths for switches with transversal head

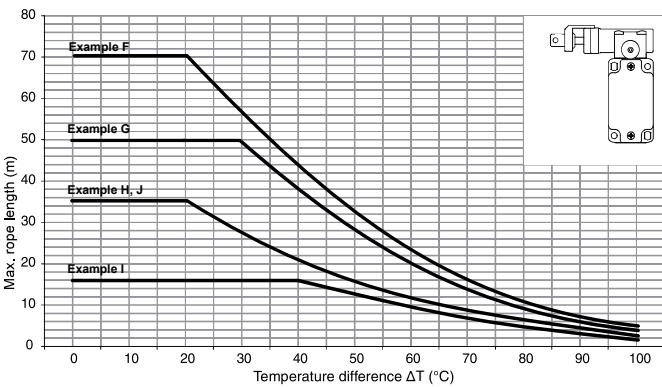

4.6 Electrical connections

⚠ Attention: The safety circuit must be connected to the NC contacts (11-12, 21-22, 31-32), with rope tensioned and reset armed. The auxiliary contacts (13-14, 23-24, 33-34) must be used for signalling only.

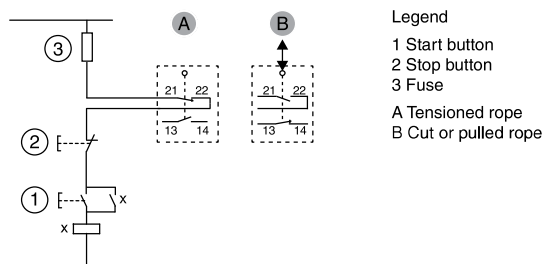

5 OPERATION

Once you have affixed the device to the machine, connected and tensioned the actuation rope, and made the electrical connections as described in the "INSTALLATION INSTRUCTIONS" paragraph, pulling on the rope must cause the electrical contacts inside the device to open.

In the versions with reset device (articles F••78, F••83 and F••84), the electrical safety contacts remain in the open state, until the end of the black indicator re-enters the green ring, and the manual rearming operation is carried out; i.e., the blue reset knob on the device head is pulled.

6 INSTRUCTIONS FOR PROPER USE

6.1 Installation

- Tighten the fixing screws of electrical conductors to a torque from 0,6 to 0,8 Nm.
- Do not stress the device with bending and torsion.
- Do not modify the device for any reason.
- Do not exceed the tightening torques specified in the present manual.
- The device carries out an operator protection function. Any inadequate installation or tampering can cause serious injuries and even death, property damage, and economic losses.
- These devices must not be bypassed, removed, turned or disabled in any other way.
- If the machine where the device is installed is used for a purpose other than that specified, the device may not provide the operator with efficient protection.
- The safety category of the system (according to EN ISO 13849-1), including the safety device, also depends on the external components connected to it and their type.
- Before installation, make sure the device is not damaged in any part.
- Avoid excessive bending of connection cables in order to prevent any short circuits or power failures.
- Do not paint or varnish the device.
- Do not drill the device.
- Do not use the device as a support or rest for other structures, such as raceways, sliding guides or similar.
- Before commissioning, make sure that the entire machine (or system) complies with all applicable standards and EMC directive requirements.
- The fitting surface of the device must always be smooth and clean.
- The documents necessary for a correct installation and maintenance are always available in the following languages: English, French, German and Italian.
- Should the installer be unable to fully understand the documents, the product must not be installed and the necessary assistance may be requested (see paragraph SUPPORT).
- Always attach the following instructions to the manual of the machine in which the device is installed.
- These operating instructions must be kept available for consultation at any time and for the whole period of use of the device.

6.2 Do not use in the following environments

- In environments where continual changes in temperature cause the formation of condensation inside the device.
- In environments where the application causes collisions, impacts or strong vibrations to the device.
- In environments containing explosive or inflammable gases or dusts. The current limit does not apply to devices declared compliant with directive ATEX 2014/34/EU.
- In environments where ice can form on the device.
- In environments containing strongly aggressive chemicals, where the products used coming into contact with the device may impair its physical or functional integrity.

6.3 Maintenance and functional tests

⚠ Attention: Never disassemble or attempt to repair the device, rope, or accessories. Should an anomaly or fault occur, replace the device, rope, or accessories.

⚠ Attention: Should the device, rope, or accessories become damaged or worn, always replace them immediately. Correct operation cannot be guaranteed when the device, rope, or accessories are deformed or damaged.

- The installer is responsible for establishing the sequence of functional tests to which the device is to be subjected before the machine is started up and during maintenance intervals.
- The sequence of the functional tests can vary depending on the machine complexity and circuit diagram, therefore the functional test sequence detailed below is to be considered as minimal and not exhaustive.
- Perform the following sequence of checks before the machine is commissioned and at least once a year (or after a prolonged shutdown):
 - 1) Check correct tensioning of the rope as described in the INSTALLATION INSTRUCTIONS paragraph.
 - 2) For articles F••79 and F••80:
 - Pull the rope when the machine is moving. The machine must stop.
 - Keeping the rope pulled, try to start the machine. The machine must not start.
 - 3) For articles F••78, F••83 and F••84:
 - Pull the rope when the machine is moving. The machine must stop, and the blue reset knob must spring once towards the device. The green ring at the bottom of the knob must be hidden by the knob itself.
 - Release the rope, and try to start the machine. The machine must not start.
 - Rarm the blue reset knob, by pulling it outwards. Check that the knob is intact, and travels freely along its axis.
 - 4) Check that the rope is affixed to the end terminals correctly and, if necessary, re-affix the rope as described in paragraph INSTALLATION INSTRUCTIONS.
 - 5) All external parts must be undamaged.
 - 6) Carefully check the condition of the external rope covering. If you discover cracks or colour variations that could impede the function of the rope itself, replace the entire rope.
 - 7) Ropes, pulleys, terminals, jumpers, and stay bolts must be in good condition, and firmly attached.
 - 8) If the device or an accessory is damaged, replace it completely.
- The device and related accessories have been created for applications in dangerous environments, and they therefore have a limited service life. After 20 years from the production date, the device and related accessories must be replaced entirely; even if they still work. The date of manufacture is positioned adjacent to the product code (see paragraph MARKINGS).

6.4 Wiring

- Keep the charge within the values specified in the electrical operation categories.
- Only connect and disconnect the device when the power is off.
- During and after the installation do not pull the electrical cables connected to the device. If traction is applied to the cables (not supported by an appropriate cable gland) internal parts of the device may be damaged.

- Always connect the protection fuse (or equivalent device) in series to the safety electrical contacts.
- At the end of the wiring, check that no contaminating element has been introduced inside the device.
- Before closing the device cover verify the correct positioning of the gaskets.
- Verify that the electrical cables, wire-end sleeves, cable numbering systems and any other parts do not obstruct the cover from closing correctly or if pressed between them do not damage or compress internal parts.
- Adhere to the following minimum and maximum cross-sections of electrical conductors designed for screw terminals.

Contact blocks 8, 9, 18:	Contact blocks 20, 21, 22, 33, 34:
min 1 x 0.5 mm ² (1 x AWG 20)	min 1 x 0.34 mm ² (1 x AWG 22)
max 2 x 2.5 mm ² (2 x AWG 14)	max 2 x 1.5 mm ² (2 x AWG 16)
- The stripping length of the cable or wire end sleeve (x) must be 8 mm (for contact blocks 8, 9, 18) or 7 mm (for contact blocks 20, 21, 22, 33, 34).



6.5 Additional prescriptions for safety applications with operator protection functions

- Provided that all previous requirements for the devices are fulfilled, for installations with operator protection function additional requirements must be observed.
- The utilization implies knowledge of and compliance with following standards: EN 60947-5-3, EN ISO 13849-1, EN 62061, EN 60204-1, EN ISO 14119, EN ISO 12100.

6.6 Limits of use

- Use the device following the instructions, complying with its operation limits and the standards in force.
- The devices have specific application limits (min. and max. ambient temperature, mechanical endurance, IP protection degree, etc.) These limitations are met by the device only if considered individually and not as combined with each other.
- The manufacturer's liability is to be excluded in the following cases:
 - 1) Use not conforming to the intended purpose;
 - 2) Failure to adhere to these instructions or regulations in force;
 - 3) Fitting operations not carried out by qualified and authorized personnel;
 - 4) Omission of functional tests.
- For the cases listed below, before proceeding with the installation contact our technical assistance service (see paragraph SUPPORT):
 - a) In nuclear power stations, trains, airplanes, cars, incinerators, medical devices or any application where the safety of two or more persons depend on the correct operation of the device;
 - b) Applications not contemplated in this instruction manual.

7 MARKINGS

The outside of the device is provided with external marking positioned in a visible place. Marking includes:

- Producer trademark
- Product code
- Batch number and date of manufacture. Example: A19 FD1-123456. The batch's first letter refers to the month of manufacture (A=January, B=February, etc.). The second and third letters refer to the year of manufacture (19 = 2019, 20 = 2020, etc...).

8 TECHNICAL DATA

8.1 Housing

FP series:	Housing made of glass fibre reinforced technopolymer, self-extinguishing, shock-proof and with double insulation One threaded conduit entry M20x1.5 (standard)
Series FD, FC:	Metal housing, baked powder coating One threaded conduit entry M20x1.5 (standard)
FL series:	Metal housing, baked powder coating Three threaded conduit entries M20x1.5 (standard)
Protection degree:	IP67 acc. to EN 60529 with cable gland of equal or higher protection degree

8.2 General data

SIL (SIL CL):	up to SIL 3 acc. to EN 62061
Performance Level (PL):	Up to PL e acc. to EN ISO 13849-1
Safety parameters:	
B10d:	2,000,000 for NC contacts
Mission time:	20 years
Ambient temperature:	-25°C ... +80°C
Storage temperature:	-40°C ... +80°C
Max. actuation frequency:	1 cycle / 6 s
Mechanical endurance:	1 million operating cycles
Max. actuation speed:	0.5 m/s
Min. actuation speed:	1 mm/s
Actuating force:	initial 63 N, final 83 N (articles F••78, F••79) initial 147 N, final 235 N (articles F••80, F••83, F••84)

8.3 Electrical data

8.3.1 Versions without connector:

Thermal current (I _{th}):	10 A
Rated insulation voltage (U _i):	500 Vac 600 Vdc 400 Vac 500 Vdc (contact blocks 20, 21, 22, 33, 34)
Rated impulse withstand voltage (U _{imp}):	6 kV 4 kV (contact blocks 20, 21, 22, 33, 34)
Conditional short circuit current:	1000 A acc. to EN 60947-5-1
Protection against short circuits:	type aM fuse 10 A 500 V
Pollution degree:	3
Utilization categories:	
Alternating current: AC15 (50÷60 Hz)	
U _e (V)	250
I _e (A)	6
Direct current: DC13	
U _e (V)	24
I _e (A)	3

8.3.2 Versions with M12 connector, 4 or 5-pole:

Thermal current (I _{th}):	4 A
Rated insulation voltage (U _i):	250 Vac 300 Vdc
Protection against short circuits:	type gG fuse 4 A 500 V
Pollution degree:	3
Utilization categories:	
Alternating current: AC15 (50÷60 Hz)	
U _e (V)	24
I _e (A)	4
Direct current: DC13	
U _e (V)	24
I _e (A)	3

8.3.3 Versions with M12 connector, 8-pole:

Thermal current (I _{th}):	2 A
Rated insulation voltage (U _i):	30 Vac 36 Vdc
Protection against short circuits:	type gG fuse 2 A 500 V
Pollution degree:	3
Utilization categories:	
Alternating current: AC15 (50÷60 Hz)	
U _e (V)	24
I _e (A)	2
Direct current: DC13	
U _e (V)	24
I _e (A)	2

8.4 Compliance with standards

EN 60947-5-1, EN 60947-1, EN 60204-1, EN ISO 14119, EN ISO 12100, EN 60529, EN ISO 13850 (for articles F••78, F••83, F••84), UL 508, CSA 22.2 No. 14.

8.5 Compliance with directives

Machinery Directive 2006/42/EC (for articles F••78, F••83, F••84),
Low Voltage Directive 2014/35/EU (for articles F••79, F••80),
EMC Directive 2014/30/EU, RoHS Directive 2011/65/EU.

9 SPECIAL VERSIONS ON REQUEST

Special versions of the device are available on request.

The special versions may differ substantially from the indications in this instruction sheet.

The installer must ensure that he has received written information from the support service regarding installation and use of the special version requested.

10 DISPOSAL

At the end of service life product must be disposed of properly, according to the rules in force in the country in which the disposal takes place.

11 SUPPORT

The device can be used for safeguarding people's physical safety, therefore in case of any doubt concerning installation or operation methods, always contact our technical support service:

Pizzato Elettrica Srl
Via Torino, 1 - 36063 Marostica (VI) - ITALY
Telephone +39.0424.470.930
E-mail tech@pizzato.com
www.pizzato.com

Our support service provides assistance in Italian and English.

12 EC CONFORMITY DECLARATION

Note: The EC Declaration of Conformity summarised below relates only to articles F••78, F••83, and F••84. For articles F••79, F••80, the EC Declaration of Conformity is available at www.pizzato.com

I, the undersigned, as a representative of the following manufacturer:

Pizzato Elettrica Srl - Via Torino, 1 - 36063 Marostica (VI) - ITALY
hereby declare that the product is in conformity with whatever prescribed by the 2006/42/EC Machine Directive. The complete version of the present conformity declaration is available on our website www.pizzato.com
Marco Pizzato

DISCLAIMER:

Subject to modifications without prior notice and errors excepted. The data given in this sheet are accurately checked and refer to typical mass production values. The device descriptions and its applications, the fields of application, the external control details, as well as information on installation and operation, are provided to the best of our knowledge. This does not in any way mean that the characteristics described may entail legal liabilities extending beyond the "General Terms of Sale", as stated in the Pizzato Elettrica general catalogue. Customers/users are not absolved from the obligation to read and understand our information and recommendations and pertinent technical standards, before using the products for their own purposes. Taking into account the great variety of applications and possible connections of the device, the examples and diagrams given in the present manual are to be considered as merely descriptive; the user is deemed responsible for checking that the specific application of the device complies with current standards. This document is a translation of the original instructions. In case of discrepancy between the present sheet and the original copy, the Italian version shall prevail. The present manual may not be reproduced, in whole or in part, without the prior written permission by Pizzato Elettrica.

© 2019 Copyright Pizzato Elettrica. All rights reserved.