

1 INFORMATION ON THIS DOCUMENT

1.1 Function

The present instruction manual provides information on installation, connection and safe use for the following articles: **HP AA******, **HP AB******, **HC ****

1.2 Target audience

The operations described in this instruction manual must be carried out by qualified personnel only, who are fully capable of understanding them, and with the technical qualifications required for operating the machines and plants in which the safety devices are to be installed.

1.3 Application field

These instructions apply exclusively to the products listed in paragraph Function, and their accessories.

1.4 Original instructions

The Italian language version is the original set of instructions for the device. Versions provided in other languages are translations of the original instructions.

2 SYMBOLS USED

i This symbol indicates any relevant additional information.

! Attention: Any failure to observe this warning note can cause damage or malfunction, including possible loss of the safety function.

3 DESCRIPTION

3.1 Device description

The safety devices described in this manual are defined as non-coded, type 1 mechanical interlocking devices acc. to EN ISO 14119.

The HP series safety hinge switches are safety devices designed and manufactured to control leaf-type opening guards. The electromechanical switch with positive opening is fully integrated in the hinge body.

The additional hinges have no internal electromechanical switch, and must be used solely for supporting the guard weight, in conjunction with a second hinge with internal electromechanical contact block. The additional hinges have code **HC ****.

3.2 Intended use of the device

- The device described in this manual is designed to be applied on industrial machines for state monitoring of movable guards.
- The direct sale of this device to the public is prohibited. Installation and use must be carried out by qualified personnel only.
- The use of the device for purposes other than those specified in this manual is prohibited.
- Any use other than as expressly specified in this manual shall be considered unintended by the manufacturer.
- Also considered unintended use:
 - a) using the device after having made structural, technical, or electrical modifications to it;
 - b) using the product in a field of application other than as described in paragraph TECHNICAL DATA.

4 INSTALLATION INSTRUCTIONS

! Attention: Installing a protective device is not sufficient to ensure operator safety or compliance with machine safety standards or directives. Before installing a protective device, perform a specific risk analysis in accordance with the key health and safety requirements in the Machinery Directive. The manufacturer guarantees only the safe functioning of the product to which this instruction manual refers, and not the functional safety of the entire machine or entire plant.

4.1 Profile drilling for HP AA **** and HC AA items

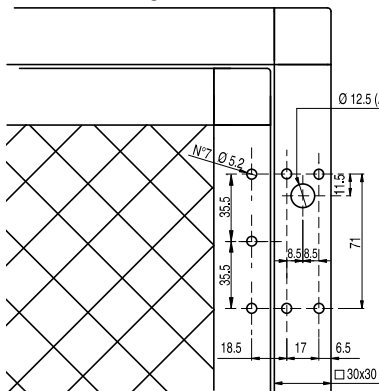

Front profile drilling

Create 7 holes with a $\varnothing 5.2$ mm diameter at the distances shown in the drawing.

The largest $\varnothing 12.5$ mm diameter hole (A) is only required for the versions with rear cable output. After drilling, remove any metal shavings or sharp edges that could damage the insulating coating of the power supply cable.

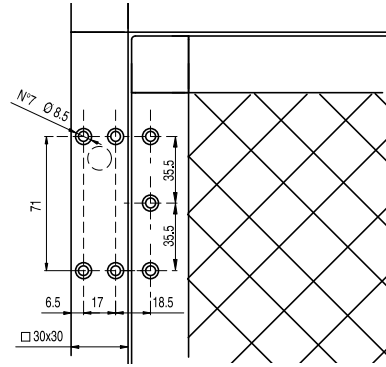

Rear profile drilling.

Create 7 holes with a $\varnothing 8.5$ mm diameter at the distances shown in the drawing.

4.2 Profile drilling for HP AB**** and HC AB items

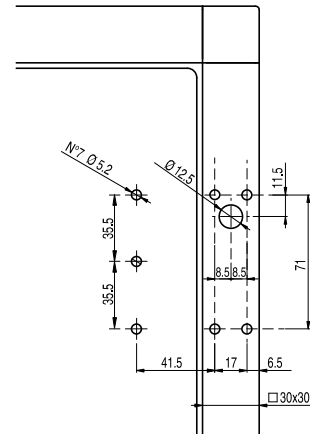

Front profile drilling

Create 7 holes with a $\varnothing 5.2$ mm diameter at the distances shown in the drawing.

The largest $\varnothing 12.5$ mm diameter hole (A) is only required for the versions with rear cable output. After drilling, remove any metal shavings or sharp edges that could damage the insulating coating of the power supply cable.

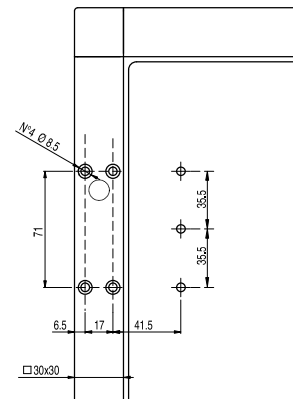

Rear profile drilling

Create 4 holes with a $\varnothing 8.5$ mm diameter at the distances shown in the drawing.

4.3 Fixing of the device

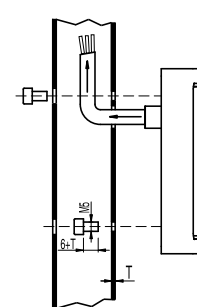

Always affix the device with 7 M5 screws with resistance class 8.8 or higher, and flat seating heads. Install screws with medium resistance thread locker. The device must never be fixed with less than 7 screws.

! Attention: Affix the device using 7 M5 screws, of 6+T mm length, where T is the thickness of the metal section used in the guard. Longer or shorter lengths can damage the hinge. As required by EN ISO 14119, the device must be fixed immovably.

Do not use a hammer for the adjustments, unscrew the screws and adjust the device manually, then tighten it in position.

The tightening torque of the screws must be between 3 and 5 Nm.

i The drawing is relevant for versions with rear cable output. In versions with cable output at the bottom or top, the cable must be positioned outside the guard.

4.4 Alignment of rotary hinge axes

! Attention: Where two or more hinges are used on the same door, always check correct alignment of the rotary axes. Misalignment of the rotary axes can cause abnormal wear to internal mechanical components, with potential loss of safety function.

4.5 Electrical connections

Contact block 2NO + 2NC		
Contacts	Version with cable	Version with M12 connector
NC	black	1
	black-white	2
NC	red	3
	red-white	4
NO	brown	5
	blue	6
NO	purple	7
	purple-white	8
⊥	yellow/green	/

Contact block 1NO + 2NC		
Contacts	Version with cable	Version with M12 connector
NC	black	3
	black-white	4
NC	red	5
	red-white	6
NO	brown	7
	blue	8
⊥	yellow/green	1

Contact block 1NO + 1NC		
Contacts	Version with cable	Version with M12 connector
NC	black	1
	grey	2
NO	brown	3
	blue	4
⊥	yellow/green	5

Contact block 2 NC		
Contacts	Version with cable	Version with M12 connector
NC	black	1
	grey	2
NC	brown	3
	blue	4
⊥	yellow/green	5

! Attention: The safety circuit must be connected to the NC contacts. The NO auxiliary contacts can be used for signalling functions.

4.6 Adjustment of the switching point

Adjustment of the switching point can be carried out using a PH1 cross-head screwdriver, used on the screw that can be reached via the hole on the hinge axis. The switches are supplied with the adjusting screw unregistered. It is therefore the responsibility of the installer to adjust the switching point correctly. Rotating the adjusting screw clockwise reduces the switching point; rotating the screw counterclockwise increases the switching point. The switching point of the contacts indicated in the travel diagrams can be adjusted from -0° to +4°. The maximum torque that can be applied to the adjusting screw is 0.2 Nm.

TRAVEL DIAGRAMS					
Contact block		NC contacts opening travel	NO contacts closing travel	Positive opening travel	Maximum travel
52C	1NO + 1NC	3°	5°	7°	180°
52D	2NC	3°	/	7°	180°
52F	1NO + 2NC	3°	5°	7°	180°
52M	2NO + 2NC	3°	5°	7°	180°
53C	1NO + 1NC	3°	1°	7°	180°
53F	1NO + 2NC	3°	1°	7°	180°
53M	2NO + 2NC	3°	1°	7°	180°
50C	1NO + 1NC	4° ▶ 1.5° ◀	4° ▶ 1.5° ◀	8°	180°
50D	2NC	4° ▶ 1.5° ◀	/	8°	180°
50F	1NO + 2NC	4° ▶ 1.5° ◀	4° ▶ 1.5° ◀	8°	180°
50M	2NO + 2NC	4° ▶ 1.5° ◀	4° ▶ 1.5° ◀	8°	180°

Legend: ▶ = opening of hinge; ◀ = closure of hinge

4.7 Checking the switching point

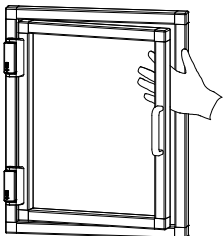

! Attention: Once adjustment is complete, check that the switching point of the switch is set so that no openings are large enough to allow upper or lower limbs, or other body parts, to be inserted and reach dangerous machine parts before they are stopped, or have otherwise entered a safe state.

The dimensions of the openings on the guards, and the relative distances from the dangerous points requiring protection, must comply with the provisions of EN ISO 13857: check the switching point and, if necessary, repeat the adjustment (see paragraph ADJUSTMENT OF THE SWITCHING POINT).

4.8 Sealing the adjustment hole of the switching point

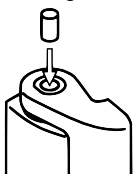

! Attention: After adjusting the switching point, always seal the hole with the appropriate protection cap supplied with the device. Failing to insert the cap can allow dusts and liquids to penetrate the electrical contacts, and impair device function.

4.9 Profile drilling for item HC LL

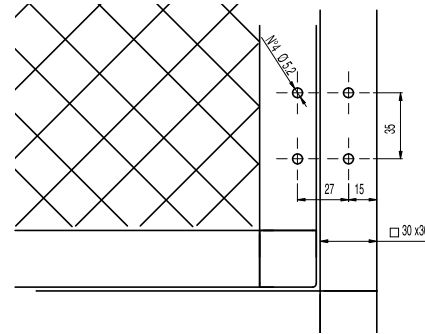

Front profile drilling

Create 4 holes with a Ø 5.2 mm diameter at the distances shown in the drawing.

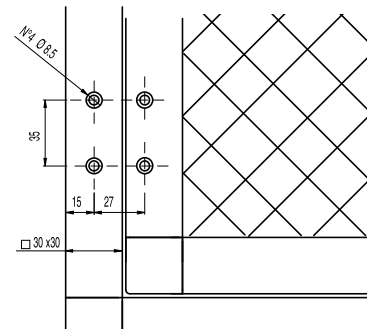

Rear profile drilling

Create 4 holes with a Ø 8.5 mm diameter at the distances shown in the drawing.

Fixing the additional hinge

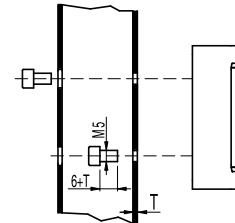

Always affix the additional hinge with 4 M5 screws with resistance class 8,8 or higher, and flat seating heads. Install screws with medium resistance thread locker. The device must never be fixed with less than 4 screws.

! Attention: Affix the device using 4 M5 screws, of 6+T mm length, where T is the thickness of the metal section used in the guard. Longer or shorter lengths can damage the hinge.

Do not use a hammer for the adjustments, unscrew the screws and adjust the device manually, then tighten it in position.

The tightening torque of the screws must be between 3 and 5 Nm.

5 OPERATION

Once the hinge switch is installed on the machine and opening guard, and electrically connected (as described in paragraph "INSTALLATION INSTRUCTIONS"), opening the guard must initiate a stop of the machine and related dangerous moving elements. It must be possible to subsequently restart the machine, only once the guard is closed.

6 INSTRUCTIONS FOR PROPER USE

6.1 Installation

- Do not stress the device with unintended, or greater than intended, bending and torsion.
- Do not modify the device for any reason.
- Do not exceed the tightening torques specified in the present manual.
- The device carries out an operator protection function. Any inadequate installation or tampering can cause serious injuries and even death, property damage, and economic losses.
- These devices must not be bypassed, removed, turned or disabled in any other way.
- If the machine where the device is installed is used for a purpose other than that specified, the device may not provide the operator with efficient protection.
- The safety category of the system (according to EN ISO 13849-1), including the safety device, also depends on the external components connected to it and their type.
- Before installation, make sure the device is not damaged in any part.
- Avoid excessive bending of connection cables in order to prevent any short circuits or power failures.
- Do not paint or varnish the device.
- Do not drill the device.
- Do not use the device as a support or rest for other structures, such as raceways, sliding guides or similar.
- Before commissioning, make sure that the entire machine (or system) complies with all applicable standards and EMC directive requirements.
- Do not apply excessive force to the device once it has reached the end of its actuation travel.
- Do not exceed the maximum actuation travel.
- The fitting surface of the device must always be smooth and clean.
- The documents necessary for a correct installation and maintenance are always available in the following languages: English, French, German and Italian.
- Should the installer be unable to fully understand the documents, the product must not be installed and the necessary assistance may be requested (see paragraph SUPPORT).
- Always attach the following instructions to the manual of the machine in which the device is installed.
- These operating instructions must be kept available for consultation at any time and for the whole period of use of the device.

6.2 Do not use in the following environments

- In environments where continual changes in temperature cause the formation of condensation inside the device.
- In environments where the application causes collisions, impacts or strong vibrations to the device.
- In environments with the presence of explosive or flammable dusts or gases.
- In environments where ice can form on the device.
- In environments containing strongly aggressive chemicals, where the products used

coming into contact with the device may impair its physical or functional integrity.

6.3 Mechanical stop

⚠ Attention: The door must always be provided with an independent end-limit mechanical stop at limit of travel. The hinge must never be responsible for stopping the door at the limit of travel, both when opening and closing.

6.4 Maintenance and functional tests

⚠ Attention: Do not disassemble or try to repair the device. In case of any malfunction or failure, replace the entire device.

⚠ Attention: In case of damages or wear it is necessary to change the whole device. Correct operation cannot be guaranteed when the device is deformed or damaged.

- The installer is responsible for establishing the sequence of functional tests to which the device is to be subjected before the machine is started up and during maintenance intervals.

- The sequence of the functional tests can vary depending on the machine complexity and circuit diagram, therefore the functional test sequence detailed below is to be considered as minimal and not exhaustive.

- Perform the following sequence of checks before the machine is commissioned and at least once a year (or after a prolonged shutdown):

- 1) Open the guard while the machine is moving. The machine must stop immediately. The stopping time of the machine must be always shorter than the time required by the operator for opening the guard and reaching the dangerous parts.
- 2) Try to start the machine while the guard is open. The machine must not start.
- 3) All external parts must be undamaged.
- 4) If the device is damaged, replace it completely.
- 5) The device must be securely locked to the door; make sure that none of the machine operator's tools can be used to disconnect the device from the door.
- 6) The device has been created for applications in dangerous environments, therefore it has a limited service life. Although still functioning, after 20 years from the date of manufacture the device must be replaced completely. The date of manufacture is placed next to the product code (see paragraph MARKINGS).

6.5 Wiring

⚠ Attention: Check that the supply voltage is correct before powering the device.

- Keep the charge within the values specified in the electrical operation categories.
- Only connect and disconnect the device when the power is off.
- Do not open the device for any reason.
- Always connect the protection fuse (or equivalent device) in series to the safety electrical contacts.
- During and after the installation do not pull the electrical cables connected to the device.
- For devices with integrated cable, the free end of the cable (if it does not have a connector) must be properly connected inside a protected housing. The cable must be adequately protected from cuts, impacts, abrasion, etc.

6.6 Additional prescriptions for safety applications with operator protection functions

Provided that all previous requirements for the devices are fulfilled, for installations with operator protection function additional requirements must be observed.

- The utilization implies knowledge of and compliance with following standards: EN 60947-5-3, EN ISO 13849-1, EN 62061, EN 60204-1, EN ISO 14119, EN ISO 12100.

6.7 Limits of use

- Use the device following the instructions, complying with its operation limits and the standards in force.

- The devices have specific application limits (min. and max. ambient temperature, mechanical endurance, IP protection degree, etc.) These limitations are met by the device only if considered individually and not as combined with each other.

- The manufacturer's liability is to be excluded in the following cases:

- 1) Use not conforming to the intended purpose;
- 2) Failure to adhere to these instructions or regulations in force;
- 3) Fitting operations not carried out by qualified and authorized personnel;
- 4) Omission of functional tests.

- For the cases listed below, before proceeding with the installation contact our technical assistance service (see paragraph SUPPORT):

- a) In nuclear power stations, trains, airplanes, cars, incinerators, medical devices or any application where the safety of two or more persons depend on the correct operation of the device;
- b) Applications not contemplated in this instruction manual.

6.8 Maximum forces and loads (for HP AA*****, HC AA, HC LL items)

The device is designed to withstand maximum forces of 1500 N in the vertical direction, 1000 N in the horizontal direction, and a maximum torque of 25 Nm, regardless of usage conditions.

⚠ Attention: Never exceed the loads listed above under any circumstances.

i The maximum loads have been verified by a fatigue test of one million operating cycles with a 90° opening angle.

One operation cycle means two movements, one to close and one to open contacts.

- Where two or more hinges are installed on the same door, the total weight of the door must never be greater than 1500 N.

- Where a single hinge is installed on the same door, the total weight of the door must never be greater than 250 N.

- When installing on doors with a base or height greater than 300 mm, always use at least one second hinge from the same series.

- When installing on doors with a base larger than 800 mm or height greater than

1600 mm, always use at least three hinges from the same series. Always install the two additional door hinges first. The safety hinge must be installed last, so that the weight of the door is supported primarily by the two additional hinges.

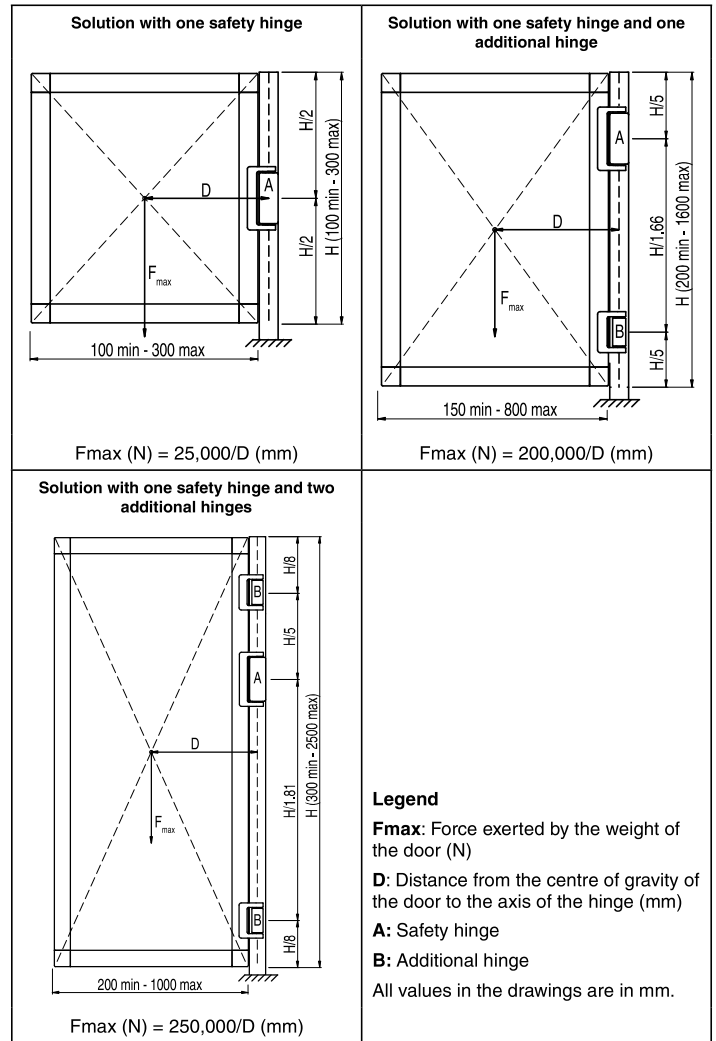

6.9 Maximum forces and loads (for HP AB*****, HC AB items)

The device is designed to withstand maximum forces of 750 N in the vertical direction, 500 N in the horizontal direction, and a maximum torque of 12 Nm, regardless of usage conditions.

⚠ Attention: Never exceed the loads listed above under any circumstances.

i The maximum loads have been verified by a fatigue test of one million operating cycles with a 90° opening angle. One operation cycle means two movements, one to close and one to open contacts.

- Where two or more hinges are installed on the same door, the total weight of the door must never be greater than 750 N.

- Where a single hinge is installed on the same door, the total weight of the door must never be greater than 125 N.

- When installing on doors with a base or height greater than 300 mm, always use at least one second hinge from the same series.

- When installing on doors with a base larger than 800 mm or height greater than 1600 mm, always use at least three hinges from the same series. Always install the two additional door hinges first. The safety hinge must be installed last, so that the weight of the door is supported primarily by the two additional hinges.



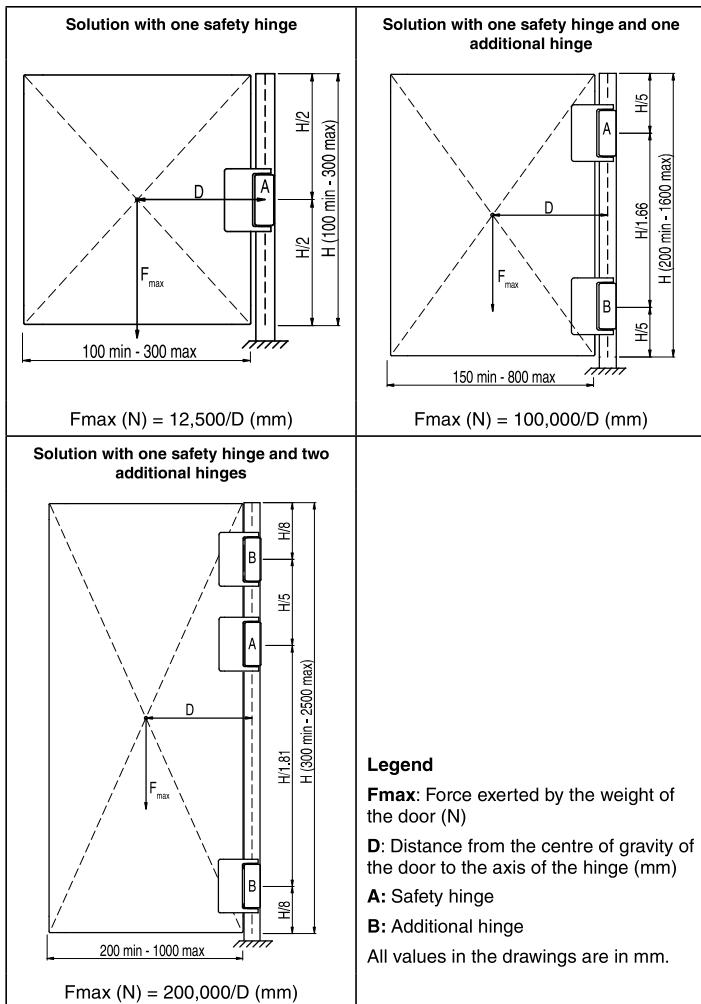

7 MARKINGS

The outside of the device is provided with external marking positioned in a visible place. Marking includes:

- Producer trademark
- Product code
- Batch number and date of manufacture. Example: A18 HP1-123456. The batch's first letter refers to the month of manufacture (A=January, B=February, etc.). The second and third letters refer to the year of manufacture (18 = 2018, 19 = 2019, etc....).

8 TECHNICAL DATA

8.1 Housing

Metal housing, powder-coated
 Protection degree:

IP67 acc. to EN 60529
 IP69K acc. to ISO 20653
 (Protect electrical cables from direct high pressure and temperature jets)
 Corrosion resistance in saline mist: > 300 hours in NSS acc. to ISO 9227

8.2 General data

SIL level (SIL CL): Up to SIL 3 acc. to EN 62061
 Performance Level (PL): Up to PL e acc. to EN ISO 13849-1
 Safety parameters: B10d: 5,000,000 for NC contacts
 Service life: 20 years
 Ambient temperature for hinges without cable: -25°C ... +80°C (standard)
 -40°C ... +80°C (T6 extended)

Ambient temperature for hinges with cable: see table
 Storage temperature: -40°C ... +80°C
 Max. operating altitude: 2000 m
 Max. actuation frequency: 1200 operating cycles/hour
 Mechanical endurance: 1 million operating cycles
 Max. actuation speed: 90°/s
 Min. actuation speed: 2°/s
 Mounting position: any

8.3 Electrical data

Rated impulse withstand voltage U_{imp}: 4 kV
 Conditional short circuit current: 1000 A acc. to EN 60947-5-1
 Pollution degree: 3

	Ambient temperature T min / T max	Thermal current I _{th}	Rated insulation voltage U _i	Protection against short circuits (fuse)
Cable with 2 contacts (type N, G)	-25°C / +70°C (a) +5°C / +70°C (b)	10 A	250 Vac	10 A 500 V type gG
Cable with 2 contacts (type H)	-25°C / +80°C (a, b, c)	10 A	250 Vac	10 A 500 V type gG
Cable with 2 contacts (type R)	-25°C / +80°C (a, b)	6 A	250 Vac	6 A 500 V type gG

	Ambient temperature T min / T max	Thermal current I _{th}	Rated insulation voltage U _i	Protection against short circuits (fuse)
Cable with 3 contacts (type N)	-25°C / +80°C (a) -5°C / +80°C (b)	6 A	250 Vac	6 A 500 V type gG
Cable with 3 contacts (type H)	-25°C / +80°C (a, b, c)	6 A	250 Vac	6 A 500 V type gG
Cable with 4 contacts (type N)	-25°C / +80°C (a) -5°C / +80°C (b)	3 A	250 Vac	3 A 500 V type gG
Cable with 4 contacts (type R)	-25°C / +80°C (a, b)	4 A	250 Vac	3 A 500 V type gG
M12 connector, 5-pole	-25°C / +80°C (a, b) -15°C / +80°C (c)	4 A	250 Vac 300 Vdc	4 A 500 V type gG
M12 connector, 8-pole	-25°C / +80°C (a, b) -15°C / +80°C (c)	2 A	30 Vac 36 Vdc	2 A 500 V type gG

Legend: (a) = fixed installation cable; (b) = flexible installation cable; (c) = mobile installation cable

	Utilization category DC13			Utilization category AC15		
	24 V	125 V	250 V	24 V	120 V	250 V
Cable with 2 contacts (type N, G, H, R)	2 A	0.4 A	0.3 A	4 A	4 A	4 A
Cable with 3 contacts (type N, H)	2 A	0.4 A	0.3 A	4 A	4 A	4 A
Cable with 4 contacts (type N)	2 A	0.4 A	0.3 A	3 A	3 A	3 A
Cable with 4 contacts (type R)	2 A	0.4 A	0.3 A	4 A	4 A	4 A
M12 connector, 5-pole	2 A	0.4 A	0.3 A	4 A	4 A	4 A
M12 connector, 8-pole	2 A	/	/	2 A	/	/



Attention: According to the standard EN 60204-1, versions with 8-pole M12 connector can be used only in SELV circuits.

Note: the type of cable fitted to the device can be identified by the last letter of the product code, for example:

HP AA050C-2DN

N = cable in PVC IEC 60332-1 (standard)
 G = cable in PVC CEI 20-22 II
 H = PUR cable, halogen free
 R = railway cable EN 50306-4
 M = M12 connector

8.4 Compliance with standards

EN 60947-5-1, EN 60947-1, EN 60204-1, EN ISO 14119, EN ISO 12100, EN 60529, ISO 20653, UL 508, CSA 22.2 No.14

8.5 Compliance with directives

Machinery Directive 2006/42/EC, EMC Directive 2014/30/UE, RoHS Directive 2011/65/UE.

9 SPECIAL VERSIONS ON REQUEST

Special versions of the device are available on request.

The special versions may differ substantially from the indications in this instruction sheet.

The installer must ensure that he has received written information from the support service regarding installation and use of the special version requested.

10 DISPOSAL



At the end of service life product must be disposed of properly, according to the rules in force in the country in which the disposal takes place.

11 SUPPORT

The device can be used for safeguarding people's physical safety, therefore in case of any doubt concerning installation or operation methods, always contact our technical support service:

Pizzato Elettrica Srl
 Via Torino, 1 - 36063 Marostica (VI) - Italy
 Telephone +39.0424.470.930
 E-mail tech@pizzato.com
 www.pizzato.com

Our support service provides assistance in Italian and English

12 EC CONFORMITY DECLARATION

I, the undersigned, as a representative of the following manufacturer:

Pizzato Elettrica s.r.l., Via Torino, 1 - 36063 Marostica (VI) - Italy
 hereby declare that the product is in conformity with whatever prescribed by the 2006/42/EC Machine Directive. The complete version of the present conformity declaration is available on our website www.pizzato.com
 Marco Pizzato

DISCLAIMER:

Subject to modifications without prior notice and errors excepted. The data given in this sheet are accurately checked and refer to typical mass production values. The device descriptions and its applications, the fields of application, the external control details, as well as information on installation and operation, are provided to the best of our knowledge. This does not in any way mean that the characteristics described may entail legal liabilities extending beyond the "General Terms of Sale", as stated in the Pizzato Elettrica general catalogue. Customers/users are not absolved from the obligation to read and understand our information and recommendations and pertinent technical standards, before using the products for their own purposes. Taking into account the great variety of applications and possible connections of the device, the examples and diagrams given in the present manual are to be considered as merely descriptive; the user is deemed responsible for checking that the specific application of the device complies with current standards. This document is a translation of the original instructions. In case of discrepancy between the present sheet and the original copy, the Italian version shall prevail. The present manual may not be reproduced, in whole or in part, without the prior written permission by Pizzato Elettrica.

© 2018 Copyright Pizzato Elettrica. All rights reserved.