

Article: **FD 2093-M2**
 Description: Safety switch with separate actuator

 Sheet: 26235-0-en-2.1.0
 Date: 10/07/2020
 Page: 1/2

Housing:

Metal housing, one threaded M20x1,5 conduit entry (FD series)

Protection degree: IP67 acc. to EN 60529 with cable gland presenting same or higher protection degree.

General data

SIL (SIL CL) up to: SIL 3 acc. to EN 62061

Performance Level (PL) up to: PL e acc. to EN ISO 13849-1

Mechanical interlock, coded: type 2 acc. to EN ISO 14119

Coding level: low acc. to EN ISO 14119

Safety parameter B10D: 2,000,000 for NC contacts

Mission time: 20 years

Max. actuation frequency: 3600 operating cycles/hour

Mechanical endurance: 1 million operating cycles

Contact block characteristics:

Contact block	Contact diagram	Contact design	Operation type	Positive opening	Contact type	Wire cross-section min.	Wire cross-section max.	Wire stripping length	Captive screws	Terminals with finger protection
20		Y+Y+X	slow action	yes	Double interruption, twin bridge	1 x 0.34 mm ² 1 x AWG 22	2 x 1.5 mm ² 2 x AWG 16	7 mm	yes	yes

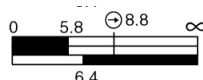
Contact block travel diagrams:

 Closed contact

 Open contact

 Positive opening travel (EN 60947-5-1)

 Opening travel 2 x 2 mm (EN 81)

 Switch pressed

 Switch released

 Reset engagement travel

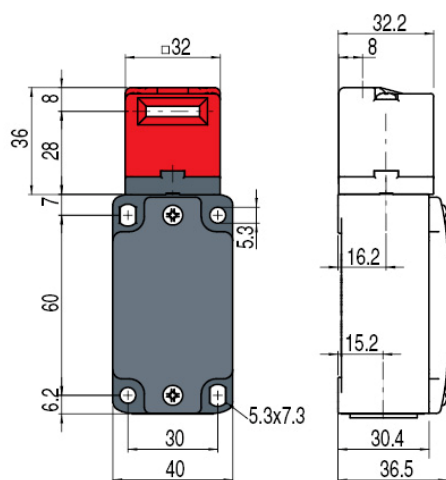
 Mechanical switching point

Positive switch opening:

Device with positive opening conforming to IEC 60947-5-1.

Tightening torques for installation:

Cover screws: 0,8 ... 1,2 Nm

Head screws: 0,8 ... 1,2 Nm

Protection caps:

1,2 ... 1,6 Nm (M20/PG13,5)

1 ... 1,4 Nm (M16/PG11)

Contact blocks screws: 0,6 ... 0,8 Nm

M5 fixing screws, body: 2 ... 3 Nm

Actuator screws VF KEY: 1,2 ... 1,6 Nm

Actuating force:

Min.: 10 N

Positive opening: 18 N

In compliance with standards:

IEC 60947-5-1, IEC 60947-1, IEC 60204-1, EN ISO 14119, EN ISO 12100, IEC 60529, EN 50581, BG-GS-ET-15, UL 508, CSA 22.2 No.14

Approvals:

EN 60947-5-1, UL 508, CSA 22.2 No.14, GB/T14048.5-2017

Compliance with the requirements of:

Machinery Directive 2006/42/EC, EMC Directive 2014/30/EU, RoHS Directive 2011/65/EU.

Markings and quality marks:

Electrical data:

 Thermal current (I_{th}): 10 A

 Rated insulation voltage (U_i): 400 Vac 500 Vdc

 Rated impulse withstand voltage (U_{imp}): 4 kV

Conditional short circuit current: 1000 A according to EN 60947-5-1

Protection against short circuits: fuse 10 A 500 V type aM

Pollution degree: 3

Utilization categories:

Alternate current: AC15 (50...60 Hz)

 U_e (V) 250 400

 I_e (A) 6 4

Direct current: DC13

 U_e (V) 24 125 250

 I_e (A) 3 0.55 0.3

Article: **FD 2093-M2**
 Description: Safety switch with separate actuator

 Sheet: 26235-0-en-2.1.0
 Date: 10/07/2020
 Page: 2/2

Features approved by IMQ

Rated insulation voltage (Ui): 500 Vac / 400 Vac (for contact blocks 2, 11, 12, 20, 21, 22, 33, 34)
 Conventional free air thermal current (Ith): 10 A
 Protection against short circuits: type aM fuse 10 A 500 V
 Rated impulse withstand voltage (Uimp): 6 kV / 4 kV (for contact blocks 20, 21, 22, 33, 34)
 Protection degree of the housing: IP67
 MV terminals (screw terminals)
 Pollution degree: 3
 Utilization category: AC15
 Operating voltage (Ue): 400 Vac (50 Hz)
 Operating current (Ie): 3 A
 Forms of the contact element: Za, Zb, Za+Za, Y+Y, X+X, Y+Y+X, Y+Y+Y, Y+X+X
 Positive opening of contacts on contact block 5, 6, 7, 9, 11, 13, 14, 16, 18, 20, 21, 22, 33, 34, 66
 In compliance with standards: EN 60947-1, EN 60947-5-1, fundamental requirements of the Low Voltage Directive 2014/35/EU.

Features approved by UL

Electrical Ratings:
 Q300 pilot duty (69 VA, 125-250 V dc)
 A600 pilot duty (720 VA, 120-600 V ac)
 Environmental Ratings: Types 1, 4X, 12, 13

Use 60 or 75 °C copper (Cu) conductor and wire size range 12, 14 AWG, stranded or solid. The terminal tightening torque of 7.1 lb in (0.8 Nm).

Mechanical stop

In accordance with the EN ISO 14119 standard, paragraph 5.2, "the position sensors should not be used as mechanical stop".

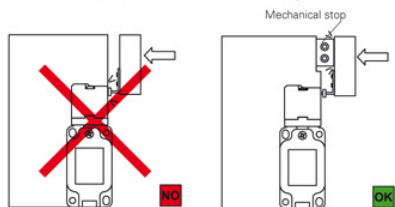



The actuator must not strike directly against the switch head.

Actuation speed:

Vmax (m/s)	Vmin (mm/s)
0,5	1

Installation of single switches with safety functions

- Use **only** switches with the symbol 
- Connect the safety circuit to **the NC normally closed contacts (11-12, 21-22 or 31-32)**.
- **The NO normally open contacts (13-14, 23-24, 33-34)** should be used **only for signalling**; these contacts are not to be connected with the safety circuit. However, if two or more switches are used on the same guard, a connection can be established between the NO contacts and the safety circuit.
 In this case at least one of the two switches must have positive opening and a normally closed contact NC (11-12, 21-22 or 31-32) must be connected to the safety circuit.
- Actuate the switch **at least up to the positive opening travel** shown in the travel diagrams with symbol .
- The actuation system must be able to exert a force that is greater than the **positive opening force**.
- The device must be affixed in compliance with EN ISO 14119.