

Article: **FR 501-M2**
Description: Position switch with plunger

Sheet: 32048-0-en-2.1.0
Date: 02/02/2021
Page: 1/3



Housing:

Polymer housing, one threaded M20x1,5 conduit entry (FR series)
Protection degree: IP67 acc. to EN 60529 with cable gland presenting same or higher protection degree

General data:







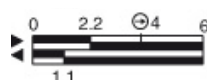

Ambient temperature: -25°C ... +80°C
Max. actuation frequency: 3600 operating cycles/hour
Mechanical endurance: 20 million operating cycles
Safety parameter B10D: 40,000,000 for NC contacts
Mechanical interlock, not coded: type 1 acc. to EN ISO 14119

Contact block characteristics:

Contact block	Contact diagram	Contact design	Operation type	Positive opening	Contact type	Wire cross-section min.	Wire cross-section max.	Wire stripping length	Captive screws	Terminals with finger protection
5		Zb	snap action	yes	Double interruption, twin bridge	1 x 0.5 mm ² 1 x AWG 20	2 x 2.5 mm ² 2 x AWG 14	8 mm	yes	yes

Contact block travel diagrams:



-  Closed contact
-  Open contact
-  Positive opening travel (EN 60947-5-1)
-  Opening travel 2 x 2 mm (EN 81)
-  Switch pressed
-  Switch released
-  R Reset engagement travel
-  S Mechanical switching point

Positive switch opening:

Device with positive opening conforming to IEC 60947-5-1.

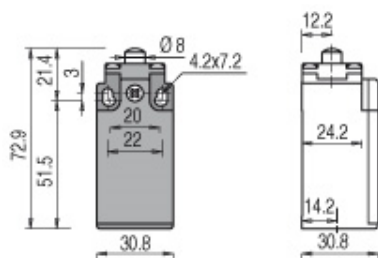

Device screw tightening torques:

Cover screws: 0,7 ... 0,9 Nm
Head screws: 0,5 ... 0,7 Nm
Lever screws: 0,7 ... 0,9 Nm
Contact blocks screws: 0,6 ... 0,8 Nm
Plugs: 1,2 ... 1,6 Nm (M20/PG13,5)
1 ... 1,4 Nm (M16/PG11)

Activating forces:

Min.: 8 N
Positive opening: 25 N

In conformity with standards:

IEC 60947-5-1, EN 60947-5-1, EN 60947-1, EN 50047, IEC 60204-1, EN 60204-1, EN ISO 14119, EN ISO 12100, IEC 60529, EN 60529, EN 50581, UL 508, CSA 22.2 No. 14.

Approvals:

IEC 60947-5-1, UL 508, CSA 22.2 No. 14, GB/T14048.5-2017.

In conformity with requirements requested by:

Low Voltage Directive 2014/35/EU, EMC Directive 2014/30/EU, RoHS Directive 2011/65/EU.

Markings and quality marks:



Electrical data:

Thermal current (I_{th}): 10 A
Rated insulation voltage (U_i): 500 Vac 600 Vdc
Rated impulse withstand voltage (U_{imp}): 6 kV
Conditional short circuit current: 1000 A according to EN 60947-5-1
Protection against short circuits: fuse 10 A 500 V type aM
Pollution degree: 3

Utilization categories:

Alternate current: AC15 (50...60 Hz)
U_e (V) 250 400 500
I_e (A) 6 4 1
Direct current: DC13
U_e (V) 24 125 250
I_e (A) 3 0.55 0.3

Article: **FR 501-M2**
Description: Position switch with plunger

Sheet: 32048-0-en-2.1.0
Date: 02/02/2021
Page: 2/3

Features approved by IMQ

Rated insulation voltage (Ui): 500 Vac / 400 Vac (for contact blocks 2, 11, 12, 20, 21, 22, 33, 34)
Conventional free air thermal current (Ith): 10 A
Protection against short circuits: type aM fuse 10 A 500 V
Rated impulse withstand voltage (Uimp): 6 kV / 4 kV (for contact blocks 20, 21, 22, 33, 34)
Protection degree of the housing: IP67
MV terminals (screw terminals)
Pollution degree: 3
Utilization category: AC15
Operating voltage (Ue): 400 Vac (50 Hz)
Operating current (Ie): 3 A
Forms of the contact element: Za, Zb, Za+Za, Y+Y, X+X, Y+Y+X, Y+Y+Y, Y+X+X
Positive opening of contacts on contact block 5, 6, 7, 9, 11, 13, 14, 16, 18, 20, 21, 22, 33, 34, 66
In compliance with standards: EN 60947-1, EN 60947-5-1, fundamental requirements of the Low Voltage Directive 2014/35/EU.

Features approved by UL

Electrical Ratings:
Q300 pilot duty (69 VA, 125-250 V dc)
A600 pilot duty (720 VA, 120-600 V ac)
Environmental Ratings: Types 1, 4X, 12, 13

For all contact blocks except 2 and 3 use 60 or 75°C copper (Cu) conductors, rigid or flexible, wire size 12, 14 AWG. Tightening torque for terminal screws of 7.1 lb in (0.8 Nm).

For contact blocks 2 and 3 use 60 or 75°C copper (Cu) conductors, rigid or flexible, wire size 14 AWG. Tightening torque for Terminal screws of 12 lb in (1.4 Nm).

The hub is to be connected to the conduit before the hub is connected to the enclosure.

Mechanical stop

Acc. to EN ISO 14119 paragraph 5.2 "the position sensors must not be used as mechanical stop".

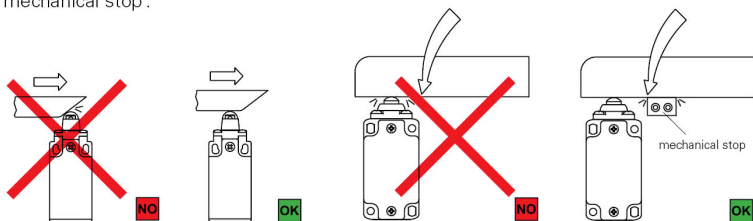

The actuator must not exceed the max. travel as indicated in the travel diagrams.

The guard must not use the switch head as a mechanical stop.

Actuation speed

Vmax (m/s)	Vmin (mm/s) L	Vmin (mm/s) R
0,5	1	0,01

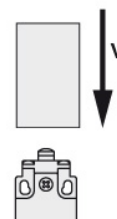

Contacts type:
R = snap action
L = slow action

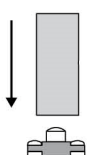
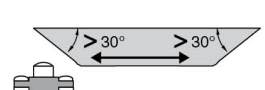
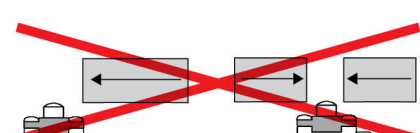

Actuation modes

Recommended application	Application to avoid This application is possible, but increased mechanical stress may shorten the operating life of the switch	Forbidden application
		

Installation of single switches with safety functions

- Use **only** switches with the symbol .
- Connect the safety circuit to **the NC normally closed contacts (11-12, 21-22 or 31-32).**
- **The NO normally open contacts (13-14, 23-24, 33-34) should be used only for signalling;** these contacts are not to be connected with the safety circuit. However, if two or more switches are used on the same guard, a connection can be established between the NO contacts and the safety circuit.
 In this case at least one of the two switches must have positive opening and a normally closed contact NC (11-12, 21-22 or 31-32) must be connected to the safety circuit.
- Actuate the switch **at least up to the positive opening travel** shown in the travel diagrams with symbol .
- The actuation system must be able to exert a force that is greater than the **positive opening force**, as specified in brackets below each article, next to the minimum force value.
- The device must be affixed in compliance with EN ISO 14119.

Whenever the machine guard is opened and during the whole opening travel, **the switch must be pressed directly** (fig. 1) **or through a rigid connection** (fig. 2).

Only in this way the positive opening of the normally closed NC contacts (11-12, 21-22, 31-32) is guaranteed.

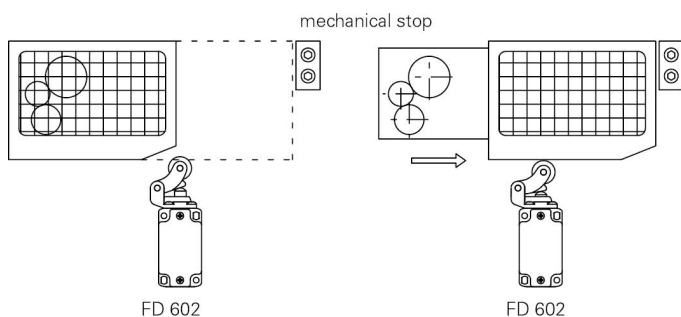

Fig.1

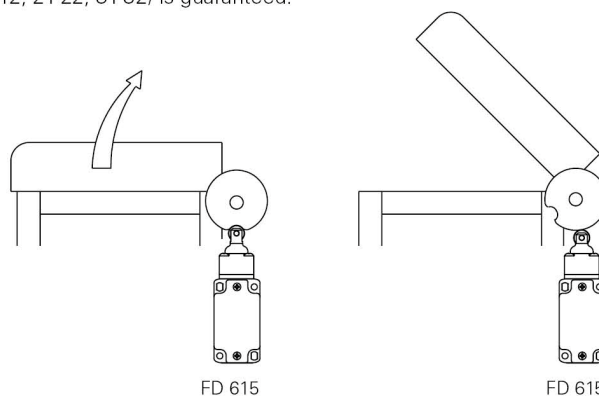

Fig.2

In safety applications with only one switch for each guard, the switches **must never be activated by a release** (fig. 3 and 4) **or through a non rigid connection** (i.e. by a spring).

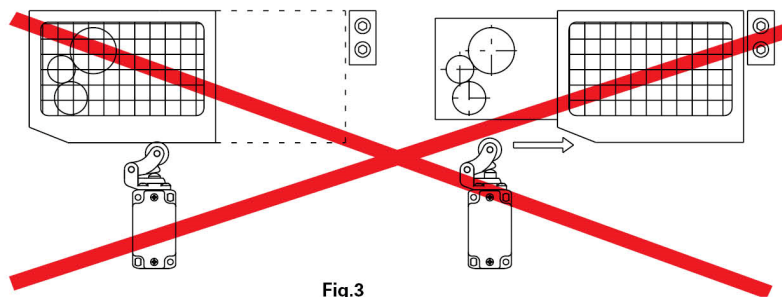

Fig.3

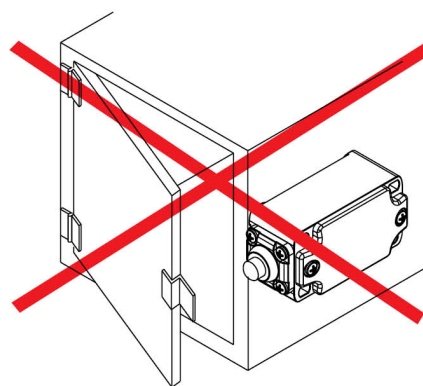

Fig.4